

LCC Modelling System

Medium signal box interior kit in 7mm scale

This kit includes elements which can be used to assemble medium signal box interior kit.

All drawings are not in scale.

LCC Modelling System is flexible and you can make easy modification. Please visit our website at www.lcut.co.uk to shop for additional LCC elements.

! We recommend resin based glue for plastic parts and PVA or wood glue for fibre board parts.

Kit contains:

- Block instrument shelf kit
- Lever frames for five sets of levers
- Five sets of levers
- Five instrument bells
- Five Instrument indicators
- Stove with chimney pipe
- Coal box
- Desk
- Chair
- Wall clock
- Token instrument
- Level crossing gate wheel

LEVEL CROSSING WHEEL

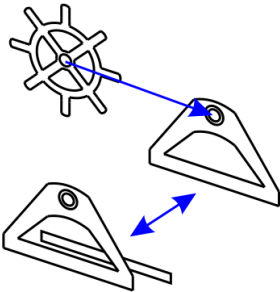

DESK

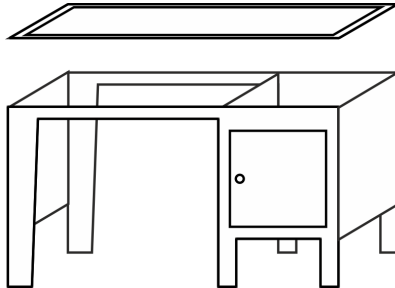

CHAIR

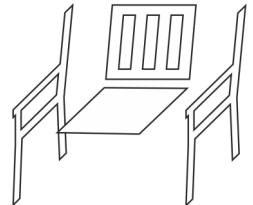

INSTRUMENT SHELF

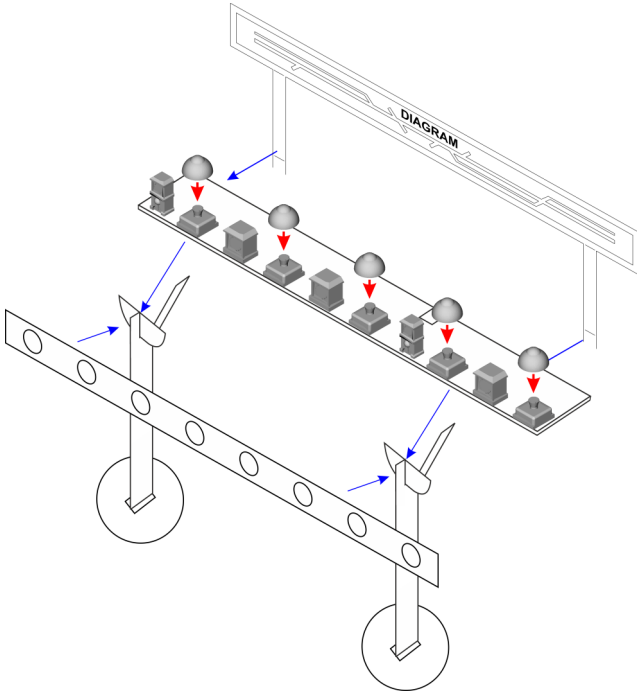

COAL BOX

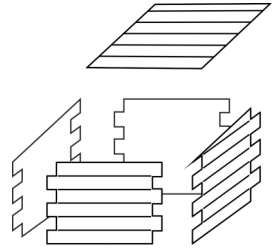

TOKEN INSTRUMENT

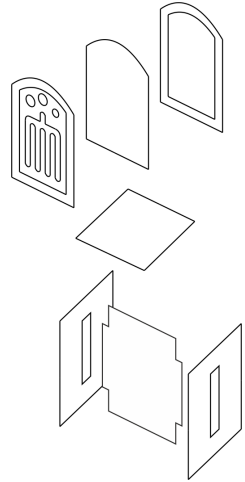

LEVERS

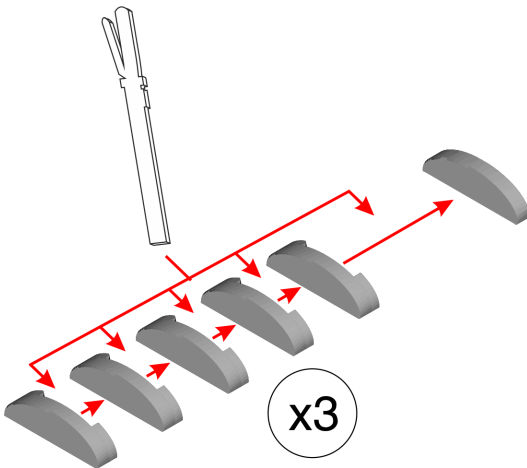

STOVE

